

G10

G16

G22



BID SPECIFICATIONS

- * DOUBLE PANE HEATED GLASS FRONT AND SIDES
- * REAR PLEXIGLASS SLIDING DOORS
- * RESERVE PAN STORAGE
- * HYDRAULIC LIFT UP FRONT GLASS
- * BACK & INSIDE STRUCTURE MADE OF HIGH GLOSS 304 STAINLESS STEEL
- * DIGITAL DIAGNOSTIC CONTROL SYSTEM WITH PROGRAMMABLE DEFROSTING
- * GALVANIZED STEEL CHASSIS CONSTRUCTION
- * INSULATED WITH DENSE NON-CFC ECOLOGIC POLYURETHANE FOAM
- * STAINLESS STEEL WORK SURFACE
- * REMOVABLE STAINLESS STEEL DECK
- * SELF-CONTAINED AIR-COOLED CONDENSING UNIT
- * UNIQUE FAN ASSISTED AIRFLOW DESIGN
- * SILVER ANODIZED ALUMINUM FINISH
- * INCLINE SHELF CAPABILITY
- * MULTIPLEXING CAPABILITY WITH GELATO, PASTRY, DELI, CHOCOLATE AND HOT CASE APPLICATIONS
- * DISPLAY CASE(S) TO BE SHIPPED FULLY ASSEMBLED
- * DISPLAY CASE(S) HAVE INTERGRATED ELECTRONIC TIME AND TEMPERATURE CONTROLLER(S) WITH HOT GAS DEFROST STANDARD ON GELATO MODELS
- * THE STANDARD LIMITED WARRANTY INCLUDES: 5 YEAR COMPRESSOR; 1 YEAR PARTS; 90 DAYS LABOR
- * DISPLAY CASE(S) TO BE LABORATORY CERTIFIED AS DESCRIBED

Easy Delivery

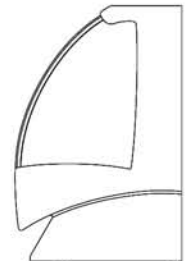

Only 35.25" Deep

STANDARD

OPTIONAL

- * CASTERS
- * REMOTE CONDENSING UNIT
- * ROLL DOWN CURTAIN
- * DECORATIVE END PANELS
- * STAINLESS STEEL TEMPLATE TO ACCOMMODATE 2.5 GALLON OR 3 GALLON ROUND ICE CREAM TUBS
- * PANS NOT INCLUDED

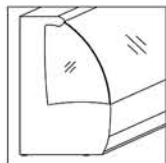

STANDARD END PANEL

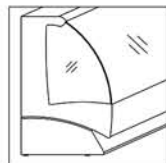

DECORATIVE END PANEL (OPTIONAL)
ADD 1.50" TO TOTAL LENGTH

- * SIDE & FRONT PANELS PAINTED IN A GLOSSY FINISH (CASE SHIP IN BUFF WHITE PRIMER)

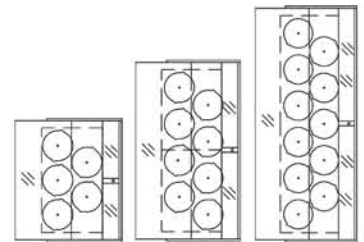

Italiana Ice Cream / Gelato Case Technical Specifications

Model	Height	*Case Length	Depth	Crated Weight (lb)	Line Voltage	Breaker Size	Amp Draw	Working Temp F	Pan Capacity		Comp. HP	Round Tubs
									4 Liter	5 Liter		
G10	54.00"	40.75"	35.25"	485	220/1/60	20 amp	8	-10 to +10	10	7	3/4 HP	5
G16	54.00"	60.50"	35.25"	617	220/1/60	30 amp	9	-10 to +10	16	11	1 HP	8
G22	54.00"	80.25"	35.25"	705	220/1/60	30 amp	10	-10 to +10	22	16	1 1/2 HP	11

* Case lengths are specified with standard end panels



STANDARD END PANEL

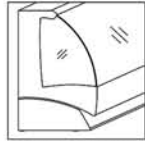

DECORATIVE END PANEL (OPTIONAL)

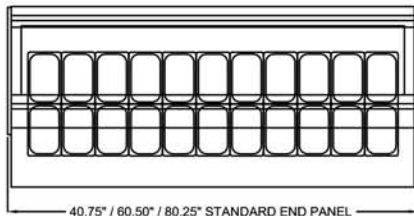

40.75" / 60.50" / 80.25" STANDARD END PANEL

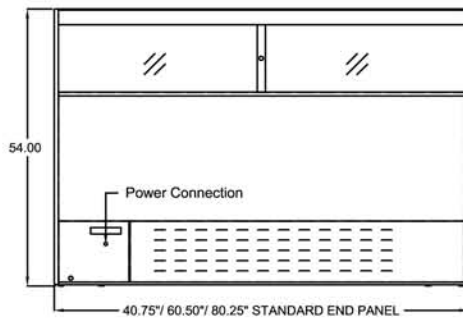

PLAN & REAR VIEW

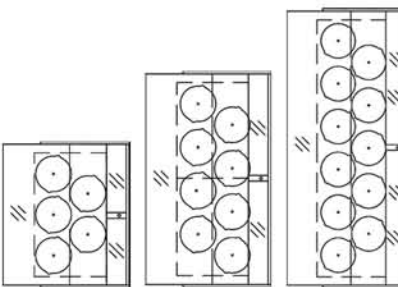
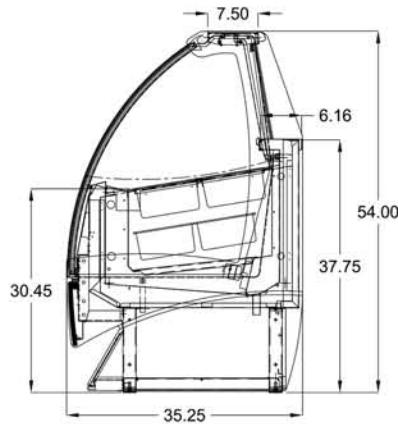

SIDE VIEW & TUB LAYOUT

Case Size	Pan Layout	Pan Size
100/2.5 G10		4 Liter
100/2.5 G10		5 Liter
150/2.8 G16		4 Liter
150/2.8 G16		5 Liter
200/2.11 G22		4 Liter
200/2.11 G22		5 Liter

LISTINGS:



ELECTRICAL CONNECTION:

Display cases are shipped with applicable junction box for hardwired installation
Options exist for several NEMA configurations
Plug and/or receptacle configurations are at the discretion of the electrical installer

NOTE:

Required ambient conditions: 75°F; 55% RH
Drawing and Specifications are subject to change without notice

CLABO North America, LLC
33300 Central Avenue
Union City, CA 94587 USA
PH 800.672.2784
FAX 510.441.0401
<http://www.otl-usa.com>