

KD43 KD64 KD85
 KD43T KD64T KD85T

| Available Heights: | |
|--------------------|--------|
| 52.75" | 57.75" |

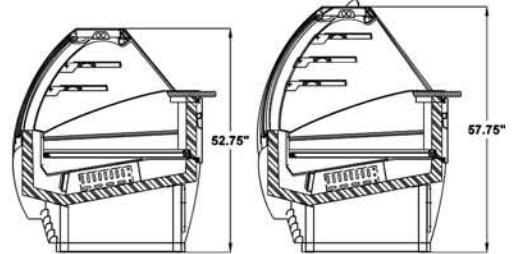
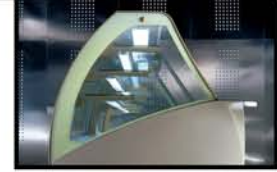

BID SPECIFICATIONS

STANDARD

- * ALL TEMPERED, DOUBLE PANE GLASS FRONT AND SIDES
- * GALVANIZED STEEL CHASSIS CONSTRUCTION
- * INSULATED WITH DENSE NON-CFC ECOLOGIC POLYURETHANE FOAM
- * INSIDE STRUCTURE MADE OF HIGH GLOSS 304 STAINLESS STEEL
- * STAINLESS STEEL WORK SURFACE
- * DIGITAL DIAGNOSTIC CONTROL SYSTEM WITH PROGRAMMABLE DEFROSTING
- * REAR PLEXIGLASS SLIDING DOORS
- * AIR-COOLED CONDENSING UNIT
- * UNIQUE FAN ASSISTED AIRFLOW DESIGN

- * HYDRAULIC FRONT GLASS OPENS UPWARD
- * REFRIGERATED DECK, NON-REFRIGERATED SHELVES
- * SILVER ANODIZED ALUMINUM TRIM
- * MULTIPLEXING CAPABILITY WITH GELATO, PASTRY, DELI, CHOCOLATE AND HOT CASE APPLICATIONS
- * DISPLAY CASE(S) TO BE SHIPPED FULLY ASSEMBLED
- * THE STANDARD LIMITED WARRANTY INCLUDES:
5 YEAR COMPRESSOR; 1 YEAR PARTS; 90 DAYS LABOR
- * DISPLAY CASE(S) TO BE LABORATORY CERTIFIED AS DESCRIBED

OPTIONAL

- * FULLY REFRIGERATED SHOWCASE OPTION
- * DOUBLE PANE SLIDING BACK DOOR AVAILABLE ON LOWER CASE MODEL
- * CASTERS
- * GRANITE WORK SURFACE (OPERATOR SIDE)
- * CHROME STUDS IN FRONT PANEL
- * CHAMPAGNE ANODIZED ALUMINUM TRIM
- * REMOTE CONDENSING UNIT
- * REAR AIR INTAKE AND DISCHARGE

- * SIDE & FRONT PANELS PAINTED IN A GLOSSY FINISH (CASE SHIP IN BUFF WHITE PRIMER)



- * DECORATIVE SIDE PANELS

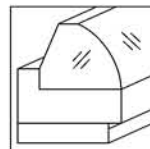

STANDARD END PANEL

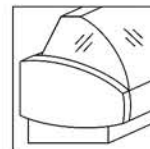

DECORATIVE END PANEL (OPTIONAL)

Korea Deli Refrigerated Case Technical Specifications

Same as Pastry Cases, no drawer

| Updated Model no. | Old Model No. | Factory Code | Case Height | *Case Length | Case Depth | Crated Weight (lb) | Line Voltage | Breaker Size | Amp Draw | Working Temp F | Comp. HP | Shelves |
|-------------------|---------------|--------------|-------------|--------------|------------|--------------------|--------------|--------------|----------|----------------|----------|---------|
| KD43 | C83K-3SC | RVS 2M | 52.75" | 43.07" | 44.33" | 734 | 115/1/60 | 20amps | 10 | 38 | 1/2 HP | 2 |
| KD43T | C83K-3SC | RVS 2M | 57.75" | 43.07" | 44.33" | 734 | 115/1/60 | 20amps | 10 | 38 | 1/2 HP | 3 |
| KD64 | C83K-5SC | RVS 3M | 52.75" | 63.74" | 44.33" | 888 | 115/1/60 | 20amps | 10 | 38 | 1/2 HP | 2 |
| KD64T | C83K-5SC | RVS 3M | 57.75" | 63.74" | 44.33" | 888 | 115/1/60 | 20amps | 10 | 38 | 1/2 HP | 3 |
| KD85 | C83K-7SC | RVS 4M | 52.75" | 84.41" | 44.33" | 1042 | 115/1/60 | 20amps | 10 | 38 | 3/4 HP | 2 |
| KD85T | C83K-7SC | RVS 4M | 57.75" | 84.41" | 44.33" | 1042 | 115/1/60 | 20amps | 10 | 38 | 3/4 HP | 3 |

T = TALL * Case lengths are specified with standard end panels

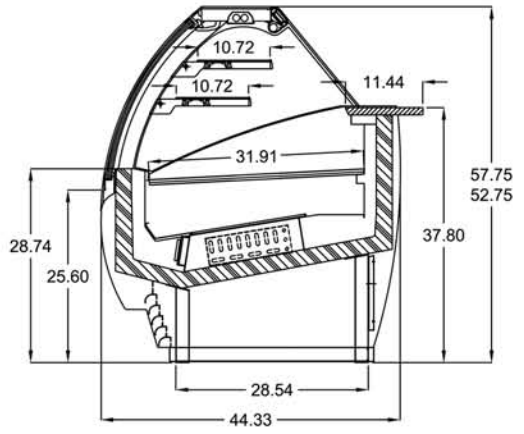
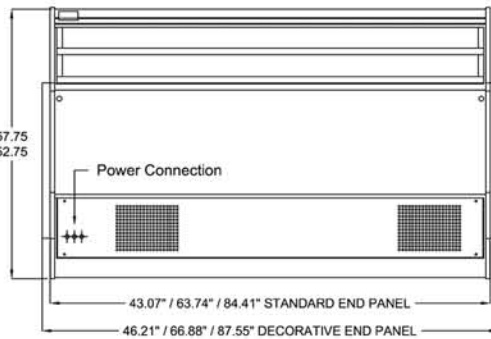
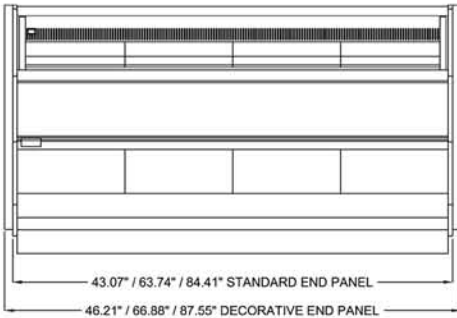

PLAN & REAR VIEW

SIDE VIEW

LISTINGS:



ELECTRICAL CONNECTION

Display cases are shipped with applicable junction box for hardwired installation
Options exist for several NEMA configurations
Plug and/or receptacle configurations are at the discretion of the electrical installer

NOTE:

Required ambient conditions: 75°F; 55% RH
Drawing and Specifications are subject to change without notice

CLABO North America, LLC
33300 Central Avenue
Union City, CA 94587 USA
PH 800.672.2784
FAX 510.441.0401
<http://www.otl-usa.com>