

KG43
KG43T

KG64
KG64T

KG85
KG85T



Available Heights:	
52.75"	57.75"

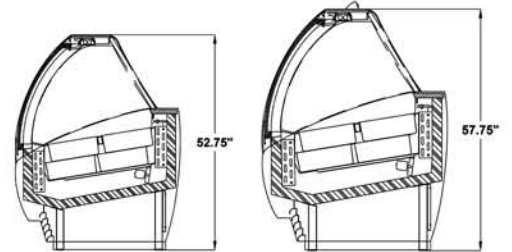

BID SPECIFICATIONS

STANDARD

- * ALL TEMPERED, DOUBLE PANE HEATED GLASS ON FRONT AND SIDES
- * GALVANIZED STEEL CHASSIS CONSTRUCTION
- * INSULATED WITH DENSE NON-CFC ECOLOGIC POLYURETHANE FOAM
- * BACK & INSIDE STRUCTURE MADE OF HIGH GLOSS 304 STAINLESS STEEL
- * DIGITAL DIAGNOSTIC CONTROL SYSTEM WITH PROGRAMMABLE DEFROSTING
- * REAR PLEXIGLASS SLIDING DOORS
- * AIR-COOLED CONDENSING UNIT
- * UNIQUE FAN ASSISTED AIRFLOW DESIGN
- * INCLINED DISPLAY
- * REMOVABLE STAINLESS STEEL DECK
- * HYDRAULIC LIFT UP FRONT GLASS
- * RESERVE PAN STORAGE
- * SILVER ANODIZED ALUMINUM TRIM
- * STAINLESS STEEL WORK SURFACE
- * MULTIPLEXING CAPABILITY WITH PASTRY, DELI, CHOCOLATE AND HOT CASE APPLICATIONS
- * DISPLAY CASE(S) TO BE SHIPPED FULLY ASSEMBLED
- * DISPLAY CASE(S) HAVE INTERGRATED ELECTRONIC TIME AND TEMPERATURE CONTROLLER(S) WITH HOT GAS DEFROST STANDARD ON GELATO MODELS
- * THE STANDARD LIMITED WARRANTY INCLUDES: 5 YEAR COMPRESSOR; 1 YEAR PARTS; 90 DAYS LABOR
- * DISPLAY CASE(S) TO BE LABORATORY CERTIFIED AS DESCRIBED

OPTIONAL

- * CASTERS
- * GRANITE WORK SURFACE (OPERATOR SIDE)
- * CHROME STUDS IN FRONT PANEL
- * CHAMPAGNE ANODIZED ALUMINUM TRIM
- * REMOTE CONDENSING UNIT
- * DECORATIVE SIDE PANELS
- * STAINLESS STEEL TEMPLATE TO ACCOMMODATE 2.5 GALLON OR 3 GALLON ROUND ICE CREAM TUBS
- * PANS NOT INCLUDED



STANDARD END PANEL



DECORATIVE END PANEL (OPTIONAL)

- * SIDE & FRONT PANELS PAINTED IN A GLOSSY FINISH (CASE SHIP IN BUFF WHITE PRIMER)

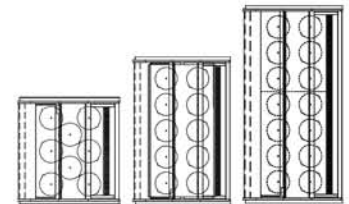

Korea Gelato / Ice Cream Technical Specifications

Updated Model no.	Old Model No.	Factory Code	Case Height	*Case Length	Case Depth	Crated Weight (lb)	Line Voltage	Breaker Size	Amp Draw	BTU		Pan Capacity			Comp. HP
										-20 Evap Temp (R404a)	Working Temp F	5 Liter	12 Liter	Rounds	
KG43	C83FK-100SC	G6	52.75"	43.07"	44.33"	910	220/1/60	20amps	9	3069	-10 to + 10	12	8	8	1 1/2 HP
KG43T	C83FK-100SC	G6	57.75"	43.07"	44.33"	954	220/1/60	20amps	9	3069	-10 to + 10	12	8	8	1 1/2 HP
KG64	C83FK-150SC	G9	52.75"	63.74"	44.33"	1086	220/1/60	20amps	10	6138	-10 to + 10	18	12	10	2 HP
KG64T	C83FK-150SC	G9	57.75"	63.74"	44.33"	1130	220/1/60	20amps	10	6138	-10 to + 10	18	12	10	2 HP
KG85	C83FK-200SC	G12	52.75"	84.41"	44.33"	1240	220/1/60	30amps	14	7850	-10 to + 10	24	16	14	2X1 HP
KG85T	C83FK-200SC	G12	57.75"	84.41"	44.33"	1284	220/1/60	30amps	14	7850	-10 to + 10	24	16	14	2X1 HP

T = TALL * Case lengths are specified with standard end panels

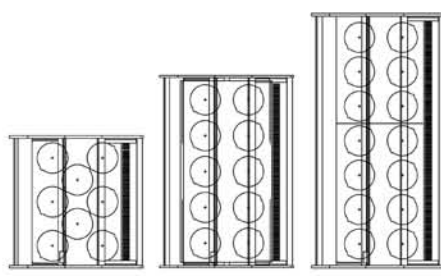
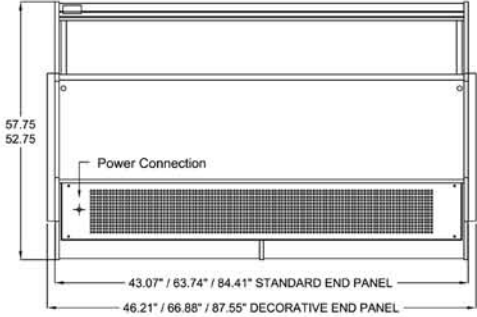
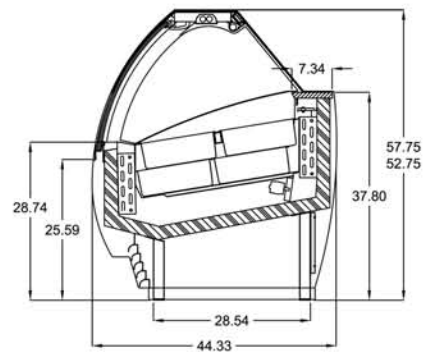
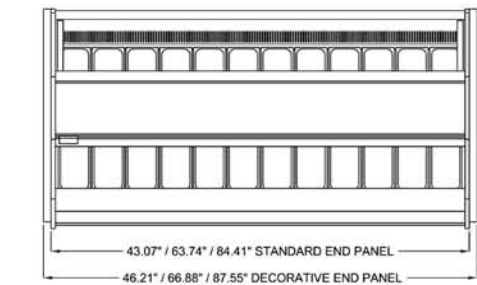
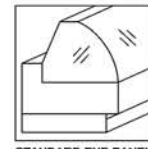

Factory Code	Pan Layout	Pan Size
G6		5 Liter
G6		12 Liter
G9		5 Liter
G9		12 Liter
G12		5 Liter
G12		12 Liter

PLAN & REAR VIEW

SIDE VIEW & TUBS LAYOUT

LISTINGS:

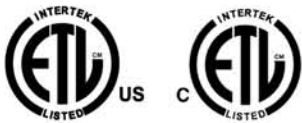

ELECTRICAL CONNECTION:

Display cases are shipped with applicable junction box for hardwired installation
Options exist for several NEMA configurations
Plug and/or receptacle configurations are at the discretion of the electrical installer

NOTE:

Required ambient conditions: 75°F; 55% RH
Drawing and Specifications are subject to change without notice

CLABO North America, LLC
33300 Central Avenue
Union City, CA 94587 USA
PH 800.672.2784
FAX 510.441.0401
<http://www.otl-usa.com>