

TRILOGY

GELATO CURVED SHOWCASE

TG30EXT-GT
TG30EXT-1300
TG30EXT-1500

TG30INT-GT
TG30INT-1300
TG30INT-1500

TG45EXT-GT
TG45EXT-1300
TG45EXT-1500

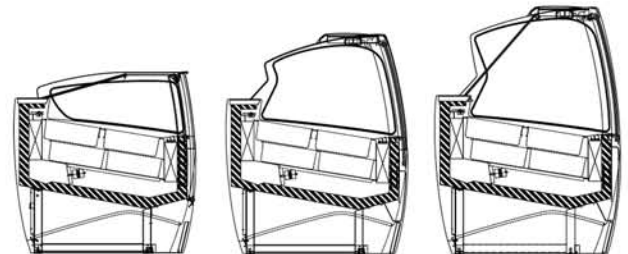

BID SPECIFICATIONS

STANDARD

- * TEMPERED, DOUBLE PANE HEATED GLASS ON FRONT AND SIDES
- * RESERVE PAN STORAGE
- * HYDRAULIC LIFT UP FRONT GLASS ON 1300 & 1500 MODES
- * HYDRAULIC TILT BACK ON GT MODEL
- * GALVANIZED STEEL CHASSIS CONSTRUCTION
- * INSULATED WITH DENSE NON-CFC ECOLOGIC POLYURETHANE FOAM
- * BACK & INSIDE STRUCTURE MADE OF HIGH GLOSS 304 STAINLESS STEEL
- * DIGITAL DIAGNOSTIC CONTROL SYSTEM WITH PROGRAMMABLE DEFROSTING
- * REAR PLEXIGLAS SLIDING DOORS
- * AIR-COOLED CONDENSING UNIT

- * UNIQUE FAN ASSISTED AIRFLOW DESIGN
- * INCLINE DISPLAY
- * ANODIZED ALUMINUM TRIM
- * MULTIPLEXING CAPABILITY WITH PASTRY, DELI CHOCOLATE AND HOT CASE APPLICATIONS
- * STAINLESS STEEL WORK SURFACE
- * REMOVABLE STAINLESS STEEL DECK
- * DISPLAY CASE(S) TO BE SHIPPED FULLY ASSEMBLED
- * DISPLAY CASE(S) HAVE INTERGRATED ELECTRONIC TIME AND TEMPERATURE CONTROLLER(S) WITH HOT GAS DEFROST STANDARD ON GELATO MODELS
- * THE STANADRD LIMITED WARRANTY INCLUDES:
5 YEAR COMPRESSOR; 1 YEAR PARTS; 90 DAYS LABOR
- * DISPLAY CASE(S) TO BE LABORATORY CERTIFIED AS DESCRIBED

OPTIONAL

- * CASTERS
- * GRANITE WORK SURFACE (OPERATOR SIDE)
- * CHAMPAGNE ANODIZED ALUMINUM TRIM
- * REMOTE CONDENSING UNIT
- * DECORATIVE SIDE PANELS

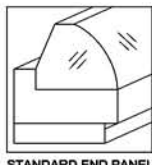

- * STAINLESS STEEL TEMPLATE TO ACCOMODATE 2.5 GALLON OR 3 GALLON ROUND ICE CREAM TUBS

- * PANS NOT INCLUDED



- * SIDE & FRONT PANELS PAINTED IN A GLOSSY FINISH (CASE SHIP IN BUFF WHITE PRIMER)

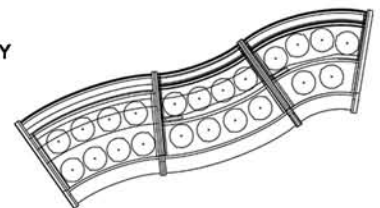

Trilogy Gelato / Ice Cream Curved Case Technical Specifications

Updated Model no.	Old Model No.	Factory Code	Case Height	Case Length	Case Depth	Crated Weight (lb)	Line Voltage	Breaker Size	Amp Draw	BTU		Pan Capacity		Comp. HP
										-20° Evap Temp (R404a)	Working Temp F	5 Liter	12 Liter	
TG30EXT-GT	C83FT-30*EXT	GA30	44.00"	*A & B*	44.33"	690	220/1/60	20amps	15	3069	-10 to + 10	12	8	1 1/2 HP
TG30EXT-1300	C83FT-30*EXT	GA30	53.75"	*A & B*	44.33"	1020	220/1/60	20amps	15	3069	-10 to + 10	12	8	1 1/2 HP
TG30EXT-1500	C83FT-30*EXT	GA30	59.00"	*A & B*	44.33"	1020	220/1/60	20amps	15	3069	-10 to + 10	12	8	1 1/2 HP
TG30INT-GT	C83FT-30*INT	GC30	44.00"	*A & B*	44.33"	844	220/1/60	20amps	15	3069	-10 to + 10	12	8	1 1/2 HP
TG30INT-1300	C83FT-30*INT	GC30	53.75"	*A & B*	44.33"	1020	220/1/60	20amps	15	3069	-10 to + 10	12	8	1 1/2 HP
TG30INT-1500	C83FT-30*INT	GC30	59.00"	*A & B*	44.33"	1020	220/1/60	20amps	15	3069	-10 to + 10	12	8	1 1/2 HP
TG45EXT-GT	C83FT-45*EXT	GA45	44.00"	*A & B*	44.33"	998	220/1/60	20amps	15	3069	-10 to + 10	9	5	1 1/2 HP
TG45EXT-1300	C83FT-45*EXT	GA45	53.75"	*A & B*	44.33"	844	220/1/60	20amps	15	3069	-10 to + 10	9	5	1 1/2 HP
TG45EXT-1500	C83FT-45*EXT	GA45	59.00"	*A & B*	44.33"	844	220/1/60	20amps	15	3069	-10 to + 10	9	5	1 1/2 HP

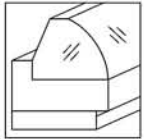

STANDARD END PANEL



DECORATIVE END PANEL (OPTIONAL)

*Case lengths are specified with standard end panels

A - Customer Side
TG30EXT = 61.76"

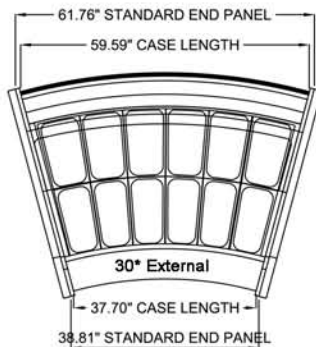

B - Server Side
TG30EXT = 38.81"

A - Customer Side
TG30INT = 38.06"

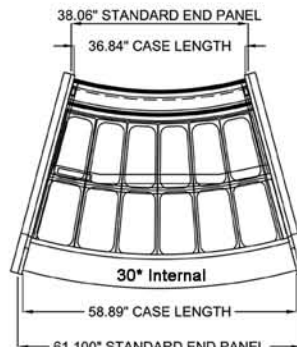

B - Server Side
TG30INT = 61.00"

A - Customer Side
TG45EXT = 56.78"

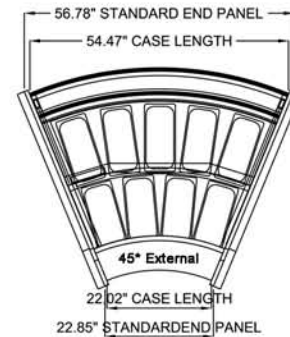

B - Server Side
TG45EXT = 22.85"

PLAN / TOP VIEWS OF CORNER CASES

LISTINGS:



ELECTRICAL CONNECTION:

Display cases are shipped with applicable junction box for hardwired installation
Options exist for several NEMA configurations
Plug and/or receptacle configurations are at the discretion of the electrical installer

NOTE:

Required ambient conditions: 75°F; 55% RH
Drawing and Specifications are subject to change without notice

CLABO North America, LLC
33300 Central Avenue
Union City, CA 94587 USA
PH 800.672.2784
FAX 510.441.0401
<http://www.otl-usa.com>