

TRILOGY

PASTRY SHOWCASE

TP43-GT
TP43-1300
TP43-1500

TP64-GT
TP64-1300
TP64-1500

TP85-GT
TP85-1300
TP85-1500

GT	1300	1500
		
LOW	MID LEVEL	TALL

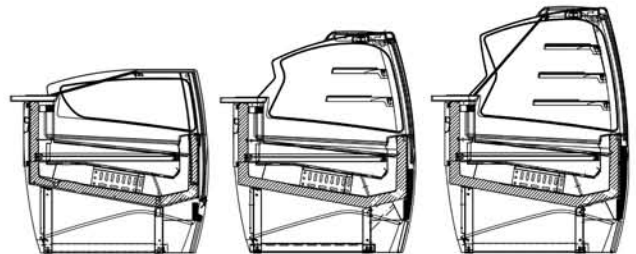

BID SPECIFICATIONS

STANDARD

- * TEMPERED, DOUBLE PANE GLASS ON FRONT AND SIDES
- * HYDRAULIC LIFT UP FRONT GLASS ON 1300 & 1500 MODELS
- * TILT BACK FRONT GLASS ON GT MODELS
- * GALVANIZED STEEL CHASSIS CONSTRUCTION
- * INSULATED WITH DENSE NON-CFC ECOLOGIC POLYURETHANE FOAM
- * INSIDE STRUCTURE MADE OF HIGH GLOSS 304 STAINLESS STEEL
- * STAINLESS STEEL WORK SURFACE
- * DIGITAL DIAGNOSTIC CONTROL SYSTEM WITH PROGRAMMABLE DEFROSTING
- * REAR PLEXIGLASS DOORS
- * PULL-OUT DRAWER

- * AIR-COOLED CONDENSING UNIT
- * UNIQUE FAN ASSISTED AIRFLOW DESIGN
- * SILVER ANODIZED ALUMINUM TRIM
- * (1300 & 1500 SERIES) REFRIGERATED DECK, NON-REFRIGERATED SHELVES
- * NO SHELVES ON GT SERIES
- * MULTIPLEXING CAPABILITY WITH GELATO, PASTRY, DELI, CHOCOLATE AND HOT CASE APPLICATIONS
- * DISPLAY CASE(S) TO BE SHIPPED FULLY ASSEMBLED
- * THE STANDARD LIMITED WARRANTY INCLUDES: 5 YEAR COMPRESSOR; 1 YEAR PARTS; 90 DAYS LABOR
- * DISPLAY CASE(S) TO BE LABORATORY CERTIFIED AS DESCRIBED

OPTIONAL

- * CASTERS
- * GRANITE WORK SURFACE (OPERATOR SIDE)
- * CHAMPAGNE ANODIZED ALUMINUM TRIM
- * REMOTE CONDENSING UNIT
- * REAR AIR INTAKE AND DISCHARGE
- * DECORATIVE SIDE PANELS

- * SIDE & FRONT PANELS PAINTED IN A GLOSSY FINISH (CASE SHIP IN BUFF WHITE PRIMER)

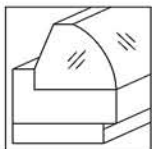

STANDARD END PANEL



DECORATIVE END PANEL (OPTIONAL)

Trilogy Pastry Refrigerated Case Technical Specifications

Same as Deli, with drawer

Updated Model no.	Old Model No.	Factory Code	Case Height	Case Length	Case Depth	Crated Weight (lb)	Line Voltage	Breaker Size	Amp Draw	Working Temp F	Comp.H.P.	Shelves
TP43-GT	C87T-3SC	RVC 2M	44.00"	43.08"	44.33"	690	115/1/60	20amps	10	38	1/3 HP	N/A
TP43-1300	C87T-3SC	RVC 2M	53.75"	43.08"	44.33"	844	115/1/60	20amps	11	38	1/3 HP	2
TP43-1500	C87T-3SC	RVC 2M	59.00"	43.08"	44.33"	998	115/1/60	20amps	12	38	1/3 HP	3
TP64-GT	C87T-5SC	RVC 3M	44.00"	63.74"	44.33"	690	115/1/60	20amps	10	38	1/2 HP	N/A
TP64-1300	C87T-5SC	RVC 3M	53.75"	63.74"	44.33"	844	115/1/60	20amps	11	38	1/2 HP	2
TP64-1500	C87T-5SC	RVC 3M	59.00"	63.74"	44.33"	998	115/1/60	20amps	12	38	1/2 HP	3
TP85-GT	C87T-7SC	RVC 4M	44.00"	84.41"	44.33"	734	115/1/60	20amps	10	38	3/4 HP	N/A
TP85-1300	C87T-7SC	RVC 4M	53.75"	84.41"	44.33"	888	115/1/60	20amps	11	38	3/4 HP	2
TP85-1500	C87T-7SC	RVC 4M	59.00"	84.41"	44.33"	1042	115/1/60	20amps	12	38	3/4 HP	3

* Case lengths are specified with standard end panels

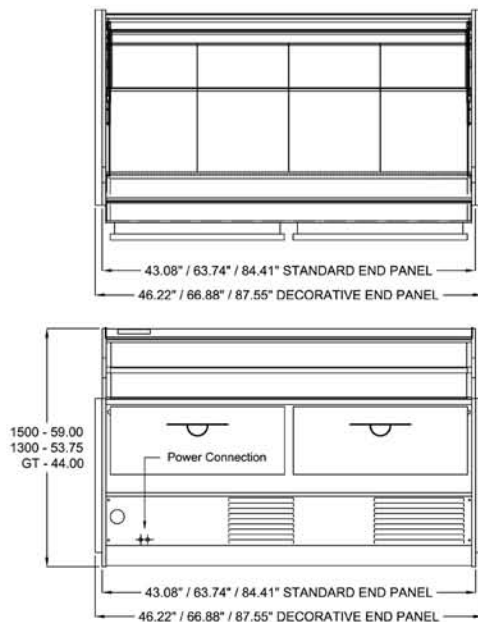

PLAN & REAR VIEW

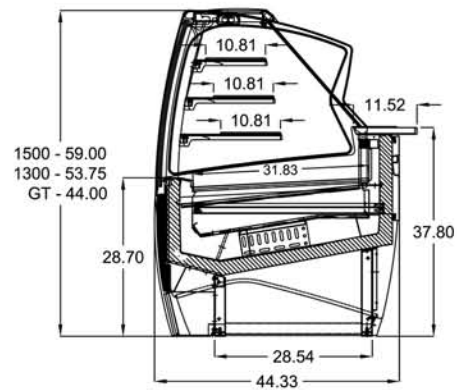
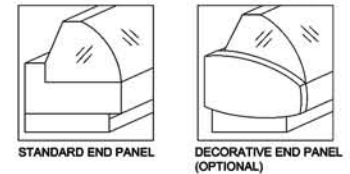

SIDE VIEW

LISTINGS:

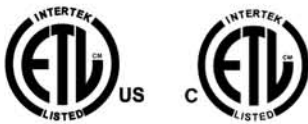

ELECTRICAL CONNECTION:

Display cases are shipped with applicable junction box for hardwired installation
Options exist for several NEMA configurations
Plug and/or receptacle configurations are at the discretion of the electrical installer

NOTE:

Required ambient conditions: 75°F; 55% RH
Drawing and Specifications are subject to change without notice

CLABO North America, LLC
33300 Central Avenue
Union City, CA 94587 USA
PH 800.672.2784
FAX 510.441.0401
<http://www.otl-usa.com>